

Muon Physics

T.E. Coan and J. Ye

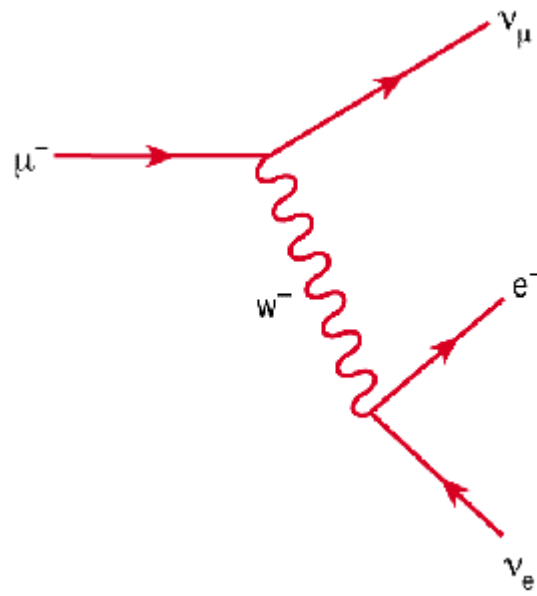

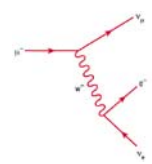

Contents

INTRODUCTION	3
OUR MUON SOURCE	3
MUON DECAY TIME DISTRIBUTION	5
DETECTOR PHYSICS	5
INTERACTION OF μ^- 'S WITH MATTER.....	7
μ^+/μ^- CHARGE RATIO AT GROUND LEVEL	9
BACKGROUNDS	10
FERMI COUPLING CONSTANT G_F	10
TIME DILATION EFFECT	11
ELECTRONICS.....	15
SOFTWARE AND USER INTERFACE	19
<i>Control</i>	21
<i>Data file format</i>	23
<i>Monitor</i>	24
<i>Rate Meter</i>	24
<i>Muons through Detector</i>	24
<i>Muon Decay Time Histogram</i>	24
THE LIFETIME FITTER	25
MUON DECAY SIMULATION.....	25
UTILITY SOFTWARE	26
REFERENCES	27
<i>Instrumentation and Technique</i>	27
<i>Cosmic Rays</i>	27
<i>General</i>	28
<i>Muon Lifetime in Matter</i>	28
GETTING STARTED	29
SUGGESTED STUDENT EXERCISES.....	31
HOW TO GET HELP.....	33

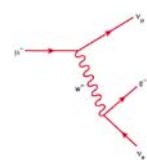

Introduction

The muon is one of nature's fundamental "building blocks of matter" and acts in many ways as if it were an unstable heavy electron, for reasons no one fully understands. Discovered in 1937 by C.W. Anderson and S.H. Neddermeyer when they exposed a cloud chamber to cosmic rays, its finite lifetime was first demonstrated in 1941 by F. Rasetti. The instrument described in this manual permits you to measure the charge averaged mean muon lifetime in plastic scintillator, to measure the relative flux of muons as a function of height above sea-level and to demonstrate the time dilation effect of special relativity. The instrument also provides a source of genuinely random numbers that can be used for experimental tests of standard probability distributions.

Our Muon Source

The top of earth's atmosphere is bombarded by a flux of high energy charged particles produced in other parts of the universe by mechanisms that are not yet fully understood. The composition of these "primary cosmic rays" is somewhat energy dependent but a useful approximation is that 98% of these particles are protons or heavier nuclei and 2% are electrons. Of the protons and nuclei, about 87% are protons, 12% helium nuclei and the balance are still heavier nuclei that are the end products of stellar nucleosynthesis. See Simpson in the reference section for more details.

The primary cosmic rays collide with the nuclei of air molecules and produce a shower of particles that include protons, neutrons, pions (both charged and neutral), kaons, photons, electrons and positrons. These secondary particles then undergo electromagnetic and nuclear interactions to produce yet additional particles in a cascade process. Figure 1 indicates the general idea. Of particular interest is the fate of the charged pions produced in the cascade. Some of these will interact via the strong force with air molecule nuclei but others will spontaneously decay (indicated by the arrow) via the weak force into a muon plus a neutrino or antineutrino:

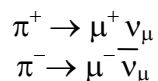

The muon does not interact with matter via the strong force but only through the weak and electromagnetic forces. It travels a relatively long instance while losing its kinetic energy and decays by the weak force into an electron plus a neutrino and antineutrino. We will detect the decays of some of the muons produced in the cascade. (Our detection efficiency for the neutrinos and antineutrinos is utterly negligible.)

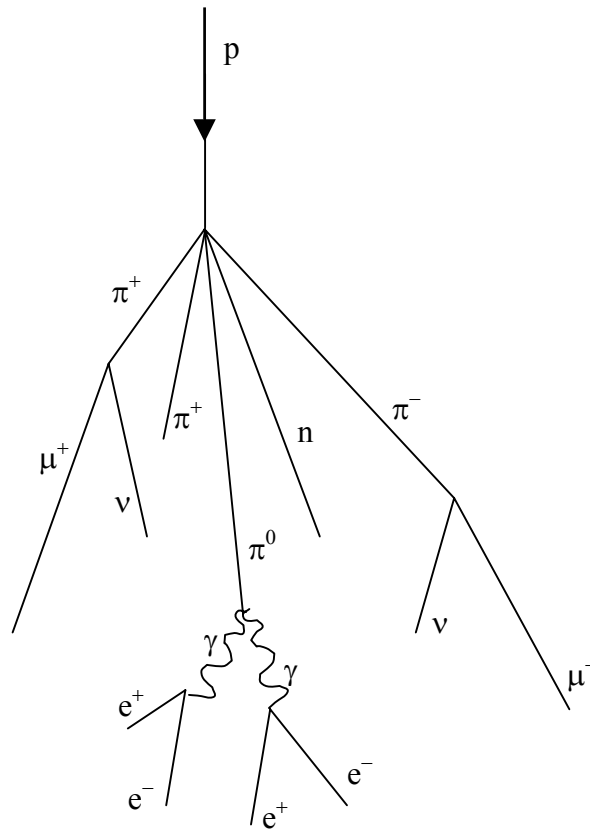
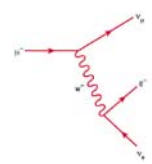
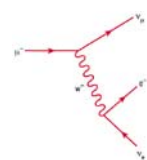

Figure 1. Cosmic ray cascade induced by a cosmic ray proton striking an air molecule nucleus.

Not all of the particles produced in the cascade in the upper atmosphere survive down to sea-level due to their interaction with atmospheric nuclei and their own spontaneous decay. The flux of sea-level muons is approximately 1 per minute per cm^2 (see <http://pdg.lbl.gov> for more precise numbers) with a mean kinetic energy of about 4 GeV.

Careful study [pdg.lbl.gov] shows that the mean production height in the atmosphere of the muons detected at sea-level is approximately 15 km. Travelling at the speed of light, the transit time from production point to sea-level is then 50 μsec . Since the lifetime of at-rest muons is more than a factor of 20 smaller, the appearance of an appreciable sea-level muon flux is qualitative evidence for the time dilation effect of special relativity.



Muon Decay Time Distribution

The decay times for muons are easily described mathematically. Suppose at some time t we have $N(t)$ muons. If the probability that a muon decays in some small time interval dt is λdt , where λ is a constant “decay rate” that characterizes how rapidly a muon decays, then the change dN in our population of muons is just $dN = -N(t)\lambda dt$, or $dN/N(t) = -\lambda dt$. Integrating, we have $N(t) = N_0 \exp(-\lambda t)$, where $N(t)$ is the number of surviving muons at some time t and N_0 is the number of muons at $t = 0$. The “lifetime” τ of a muon is the reciprocal of λ , $\tau = 1/\lambda$. This simple exponential relation is typical of radioactive decay.

Now, we do not have a single clump of muons whose surviving number we can easily measure. Instead, we detect muon decays from muons that enter our detector at essentially random times, typically one at a time. It is still the case that their decay time distribution has a simple exponential form of the type described above. By decay time distribution $D(t)$, we mean that the time-dependent probability that a muon decays in the time interval between t and $t + dt$ is given by $D(t)dt$. If we had started with N_0 muons, then the fraction $-dN/N_0$ that would on average decay in the time interval between t and $t + dt$ is just given by differentiating the above relation:

$$\begin{aligned} -dN &= N_0 \lambda \exp(-\lambda t) dt \\ -dN/N_0 &= \lambda \exp(-\lambda t) dt \end{aligned}$$

The left-hand side of the last equation is nothing more than the decay probability we seek, so $D(t) = \lambda \exp(-\lambda t)$. This is true regardless of the starting value of N_0 . That is, the distribution of decay times, for new muons entering our detector, is also exponential with the very same exponent used to describe the surviving population of muons. Again, what we call the muon lifetime is $\tau = 1/\lambda$.

Because the muon decay time is exponentially distributed, it does not matter that the muons whose decays we detect are not born in the detector but somewhere above us in the atmosphere. An exponential function always “looks the same” in the sense that whether you examine it at early times or late times, its e-folding time is the same.

Detector Physics

The active volume of the detector is a plastic scintillator in the shape of a right circular cylinder of 15 cm diameter and 12.5 cm height placed at the bottom of the black anodized aluminum alloy tube. Plastic scintillator is transparent organic material made by mixing together one or more fluors with a solid plastic solvent that has an aromatic ring structure. A charged particle passing through the scintillator will lose some of its kinetic energy by ionization and atomic excitation of the solvent molecules. Some of this deposited energy is then transferred to the fluor molecules whose electrons are then promoted to excited states. Upon radiative de-excitation, light in the blue and near-UV portion of the electromagnetic spectrum is emitted with a typical decay time of a few nanoseconds. A typical photon yield for a plastic scintillator is 1 optical photon emitted per 100 eV of

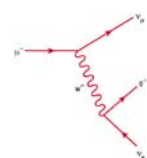

deposited energy. The properties of the polyvinyltoluene-based scintillator used in the muon lifetime instrument are summarized in table 1.

To measure the muon's lifetime, we are interested in only those muons that enter, slow, *stop* and then *decay* inside the plastic scintillator. Figure 2 summarizes this process. Such muons have a maximum kinetic energy of only about 150 MeV as they enter the tube. As a muon slows to a stop, the excited scintillator emits light that is detected by a photomultiplier tube (PMT), eventually producing a logic signal that triggers a timing clock. (See the electronics section below for more detail.) A stopped muon, after a bit, decays into an electron, a neutrino and an anti-neutrino. (See the next section for an important qualification of this statement.) Since the electron mass is so much smaller than the muon mass, $m_\mu/m_e \sim 210$, the electron tends to be very energetic and to produce scintillator light essentially all along its pathlength. The neutrino and anti-neutrino also share some of the muon's total energy but they entirely escape detection. This second burst of scintillator light is also seen by the PMT and used to trigger the timing clock. The distribution of time intervals between successive clock triggers for a set of muon decays is the physically interesting quantity used to measure the muon lifetime.

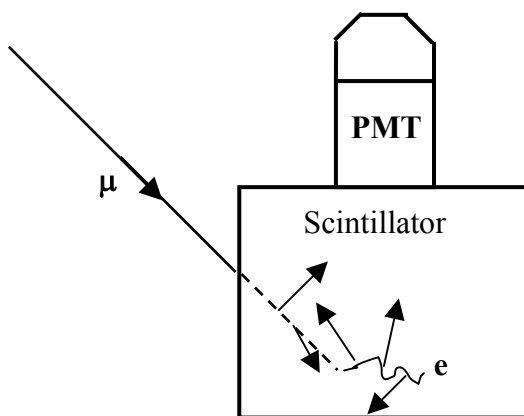
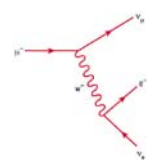

Figure 2. Schematic showing the generation of the two light pulses (short arrows) used in determining the muon lifetime. One light pulse is from the slowing muon (dotted line) and the other is from its decay into an electron or positron (wavy line).

Table 1. General Scintillator Properties

Mass density	1.032 g/cm ³
Refractive index	1.58
Base material	Polyvinyltoluene
Rise time	0.9 ns
Fall time	2.4 ns
Wavelength of Maximum Emission	423 nm



Interaction of μ^- 's with matter

The muons whose lifetime we measure necessarily interact with matter. Negative muons that stop in the scintillator can bind to the scintillator's carbon and hydrogen nuclei in much the same way as electrons do. Since the muon is not an electron, the Pauli exclusion principle does not prevent it from occupying an atomic orbital already filled with electrons. Such bound negative muons can then interact with protons

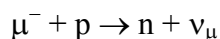

before they spontaneously decay. Since there are now two ways for a *negative* muon to disappear, the effective lifetime of negative muons in matter is somewhat less than the lifetime of positively charged muons, which do not have this second interaction mechanism. Experimental evidence for this effect is shown in figure 3 where “disintegration” curves for positive and negative muons in aluminum are shown. (See Rossi, 1952) The abscissa is the time interval t between the arrival of a muon in the aluminum target and its decay. The ordinate, plotted logarithmically, is the number of muons greater than the corresponding abscissa. These curves have the same meaning as curves representing the survival population of radioactive substances. The slope of the curve is a measure of the effective lifetime of the decaying substance. The muon lifetime we measure with this instrument is an average over both charge species so the mean lifetime of the detected muons will be somewhat less than the free space value $\tau_\mu = 2.19703 \pm 0.00004 \mu\text{sec}$.

The probability for nuclear absorption of a stopped *negative* muon by one of the scintillator nuclei is proportional to Z^4 , where Z is the atomic number of the nucleus [Rossi, 1952]. A stopped muon captured in an atomic orbital will make transitions down to the K-shell on a time scale short compared to its time for spontaneous decay [Wheeler]. Its Bohr radius is roughly 200 times smaller than that for an electron due to its much larger mass, increasing its probability for being found in the nucleus. From our knowledge of hydrogenic wavefunctions, the probability density for the bound muon to be found inside the nucleus is proportional to Z^3 . Once inside the nucleus, a muon's probability for encountering a proton is proportional to the number of protons there and so scales like Z . The net effect is for the overall absorption probability to scale like Z^4 . Again, this effect is relevant only for negatively charged muons.

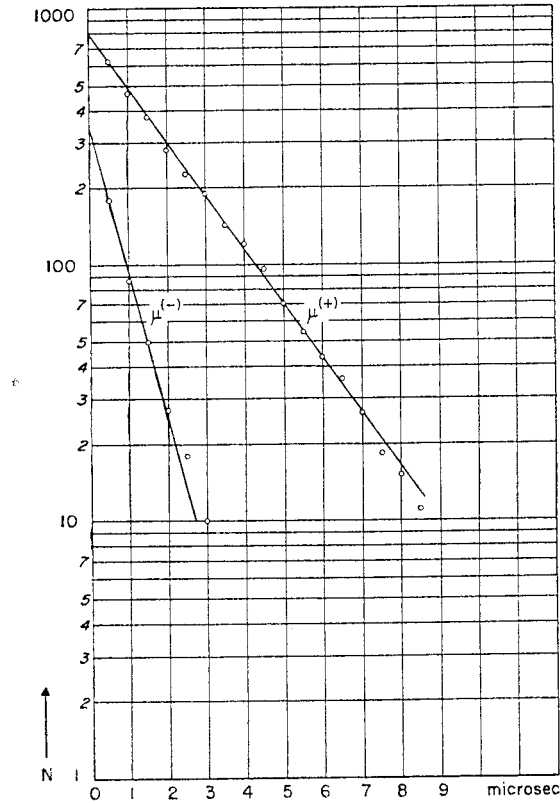
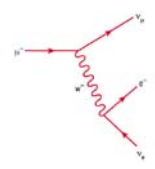

Figure 3. Disintegration curves for positive and negative muons in aluminum. The ordinates at $t = 0$ can be used to determine the relative numbers of negative and positive muons that have undergone spontaneous decay. The slopes can be used to determine the decay time of each charge species. (From Rossi, p168.)

μ^+/μ^- Charge Ratio at Ground Level

Our measurement of the muon lifetime in plastic scintillator is an average over both negatively and positively charged muons. We have already seen that μ^- 's have a lifetime somewhat smaller than positively charged muons because of weak interactions between negative muons and protons in the scintillator nuclei. This interaction probability is proportional to Z^4 , where Z is the atomic number of the nuclei, so the lifetime of negative muons in scintillator and carbon should be very nearly equal. This latter lifetime τ_c is measured to be $\tau_c = 2.043 \pm 0.003 \mu\text{sec}$. [Reiter, 1960]

It is easy to determine the expected average lifetime τ_{obs} of positive and negative muons in plastic scintillator. Let λ^- be the decay rate per negative muon in plastic scintillator and let λ^+ be the corresponding quantity for positively charged muons. If we then let N^- and N^+ represent the number of negative and positive muons incident on the scintillator per unit time, respectively, the average observed decay rate $\langle \lambda \rangle$ and its corresponding lifetime τ_{obs} are given by

$$\begin{aligned} \langle \lambda \rangle &= \frac{N^+ \lambda^+ + N^- \lambda^-}{N^+ + N^-} \\ &= \frac{\rho \lambda^+ + \lambda^-}{1 + \rho} \\ \Rightarrow \langle \lambda \rangle^{-1} &= \frac{1 + \rho}{\lambda^- + \rho \lambda^+} \\ \tau_{\text{obs}} &= (1 + \rho) \left(\frac{1}{\tau^-} + \frac{\rho}{\tau^+} \right)^{-1} \\ &= (1 + \rho) \frac{\tau^- \tau^+}{\tau^+ + \rho \tau^-} \end{aligned}$$

where $\rho \equiv N^+/N^-$, $\tau^- \equiv (\lambda^-)^{-1}$ is the lifetime of negative muons in scintillator and $\tau^+ \equiv (\lambda^+)^{-1}$ is the corresponding quantity for positive muons.

Due to the Z^4 effect, $\tau^- = \tau_c$ for plastic scintillator, and we can set τ^+ equal to the free space lifetime value τ_μ since positive muons are not captured by the scintillator nuclei. Setting $\rho=1$ allows us to estimate the average muon lifetime we expect to observe in the scintillator.

We can *measure* ρ for the momentum range of muons that stop in the scintillator by rearranging the above equation:

$$\rho = -\frac{\tau^+}{\tau^-} \left(\frac{\tau^- \tau_{\text{obs}}}{\tau^+ - \tau_{\text{obs}}} \right)$$

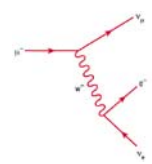

Backgrounds

The detector responds to any particle that produces enough scintillation light to trigger its readout electronics. These particles can be either charged, like electrons or muons, or neutral, like photons, that produce charged particles when they interact inside the scintillator. Now, the detector has no knowledge of whether a penetrating particle stops or not inside the scintillator and so has no way of distinguishing between light produced by muons that stop and decay inside the detector, from light produced by a pair of through-going muons that occur one right after the other. This important source of background events can be dealt with in two ways. First, we can restrict the time interval during which we look for the two successive flashes of scintillator light characteristic of muon decay events. Secondly, we can estimate the background level by looking at large times in the decay time histogram where we expect few events from genuine muon decay.

Fermi Coupling Constant G_F

Muons decay via the weak force and the Fermi coupling constant G_F is a measure of the strength of the weak force. To a good approximation, the relationship between the muon lifetime τ and G_F is particularly simple:

$$\tau = \frac{192\pi^3\hbar^7}{G_F^2 m^5 c^4}$$

where m is the mass of the muon and the other symbols have their standard meanings. Measuring τ with this instrument and then taking m from, say, the Particle Data Group (<http://www.pdg.lbl.gov>) produces a value for G_F .

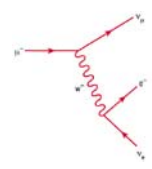

Time Dilation Effect

A measurement of the muon stopping rate at two different altitudes can be used to demonstrate the time dilation effect of special relativity. Although the detector configuration is not optimal for demonstrating time dilation, a useful measurement can still be performed without additional scintillators or lead absorbers. Due to the finite size of the detector, only muons with a typical kinetic energy of about 160 MeV will stop inside the plastic scintillator. The stopping rate is measured from the total number of observed muon decays recorded by the instrument in some time interval. This rate in turn is proportional to the flux of muons with kinetic energy of about 160 MeV and this flux decreases with diminishing altitude as the muons descend and decay in the atmosphere. After measuring the muon stopping rate at one altitude, predictions for the stopping rate at another altitude can be made with and without accounting for the time dilation effect of special relativity. A second measurement at the new altitude distinguishes between competing predictions.

A comparison of the muon stopping rate at two different altitudes should account for the muon's energy loss as it descends into the atmosphere, variations with energy in the shape of the muon energy spectrum, and the varying zenith angles of the muons that stop in the detector. Since the detector stops only low energy muons, the stopped muons detected by the low altitude detector will, at the elevation of the higher altitude detector, necessarily have greater energy. This energy difference $\Delta E(h)$ will clearly depend on the pathlength between the two detector positions.

Vertically travelling muons at the position of the higher altitude detector that are ultimately detected by the lower detector have an energy larger than those stopped and detected by the upper detector by an amount approximately equal to $160 \text{ MeV} + \Delta E(h)$. If the shape of the muon energy spectrum changes significantly with energy, then the relative muon stopping rates at the two different altitudes will reflect this difference in spectrum shape at the two different energies. (This is easy to see if you suppose muons do not decay at all.) This variation in the spectrum shape can be corrected for by calibrating the detector in a manner described below.

Like all charged particles, a muon loses energy through coulombic interactions with the matter it traverses. The average energy loss rate in matter for singly charged particles traveling close to the speed of light is approximately 2 MeV/g/cm^2 , where we measure the thickness s of the matter in units of g/cm^2 . Here, $s = \rho x$, where ρ is the mass density of the material through which the particle is passing, measured in g/cm^3 , and the x is the particle's pathlength, measured in cm. (This way of measuring material thickness in units of g/cm^2 allows us to compare effective thicknesses of two materials that might have very different mass densities.) A more accurate value for energy loss can be determined from the Bethe-Bloch equation.

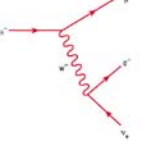

$$\begin{aligned}\frac{dE}{dx} &= -\frac{4\pi N_e^4}{mc^2\beta^2} z^2 \left(\ln \frac{2mc^2\beta^2\gamma^2}{I} - \beta^2 \right) \\ &= 0.3071 \left(\frac{\text{MeV}}{\text{g/cm}^2} \right) \frac{Z}{A} \rho \frac{1}{\beta^2} z^2 \left(\ln \frac{2mc^2\beta^2\gamma^2}{I} - \beta^2 \right)\end{aligned}$$

Here N is the number of electrons in the stopping medium per cm^3 , e is the electronic charge, z is the atomic number of the projectile, Z and A are the atomic number and weight, respectively, of the stopping medium. The velocity of the projectile is β in units of the speed c of light and its corresponding Lorentz factor is γ . The symbol I denotes the mean excitation energy of the stopping medium atoms. Approximately, $I=AZ$, where $A \cong 13$ eV. More accurate values for I , as well as corrections to the Bethe-Bloch equation, can be found in [Leo, p26].

A simple estimate of the energy lost ΔE by a muon as it travels a vertical distance H is $\Delta E = 2 \text{ MeV/g/cm}^2 * H * \rho_{\text{air}}$, where ρ_{air} is the density of air, possibly averaged over H using the density of air according to the “standard atmosphere.” Here the atmosphere is assumed isothermal and the air pressure p at some height h above sea level is parameterized by $p = p_0 \exp(-h/h_0)$, where $p_0 = 1030 \text{ g/cm}^2$ is the total thickness of the atmosphere and $h_0 = 8.4 \text{ km}$. The units of pressure may seem unusual to you but they are completely acceptable. From hydrostatics, you will recall that the pressure P at the base of a stationary fluid is $P = \rho gh$. Dividing both sides by g yields $P/g = \rho h$, and you will then recognize the units of the right hand side as g/cm^2 . The air density ρ , in familiar units of g/cm^3 , is given by $\rho = -dp/dh$.

If the transit time for a particle to travel vertically from some height H down to sea level, all measured in the lab frame, is denoted by t , then the corresponding time in the particle’s rest frame is t' and given by

$$t' = \int_H^0 \frac{dh}{c\beta(h)\gamma(h)}$$

Here β and γ have their usual relativistic meanings for the projectile and are measured in the lab frame. Since relativistic muons lose energy at essentially a constant rate when travelling through a medium of mass density ρ , $dE/ds = C_0$, so we have $dE = \rho C_0 dh$, with $C_0 = 2 \text{ MeV/(g/cm}^2)$. Also, from the Einstein relation, $E = \gamma mc^2$, $dE = mc^2 d\gamma$, so $dh = (mc^2/\rho C_0) d\gamma$. Hence,

$$\begin{aligned}t' &= \frac{mc}{\rho C_0} \int_{\gamma_1}^{\gamma_2} \frac{d\gamma}{\beta\gamma} \\ &= \frac{mc}{\rho C_0} \int_{\gamma_1}^{\gamma_2} \frac{d\gamma}{\sqrt{\gamma^2 - 1}}\end{aligned}$$

Here γ_1 is the muon’s gamma factor at height H and γ_2 is its gamma factor just before it enters the scintillator. We can take $\gamma_2 = 1.5$ since we want muons that stop in the

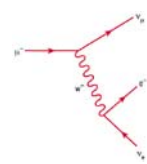

scintillator and assume that on average stopped muons travel halfway into the scintillator, corresponding to a distance $s = 10 \text{ g/cm}^2$. The entrance muon momentum is then taken from range-momentum graphs at the Particle Data Group WWW site and the corresponding γ_2 computed. The lower limit of integration is given by $\gamma_1 = E_1/mc^2$, where $E_1 = E_2 + \Delta E$, with $E_2 = 160 \text{ MeV}$. The integral can be evaluated numerically. (See, for example, Internet site: http://people.hofstra.edu/faculty/Stefan_Waner/RealWorld/integral/integral.html)

Hence, the ratio R of muon stopping rates for the same detector at two different positions separated by a vertical distance H , and ignoring for the moment any variations in the shape of the energy spectrum of muons, is just $R = \exp(-t'/\tau)$, where τ is the muon proper lifetime.

When comparing the muon stopping rates for the detector at two different elevations, we must remember that muons that stop in the lower detector have, at the position of the upper detector, a larger energy. If, say, the relative muon abundance grows dramatically with energy, then we would expect a relatively large stopping rate at the lower detector simply because the starting flux at the position of the upper detector was so large, and not because of any relativistic effects. Indeed, the muon momentum spectrum does peak, at around $p = 500 \text{ MeV/c}$ or so, although the precise shape is not known with high accuracy. See figure 4.

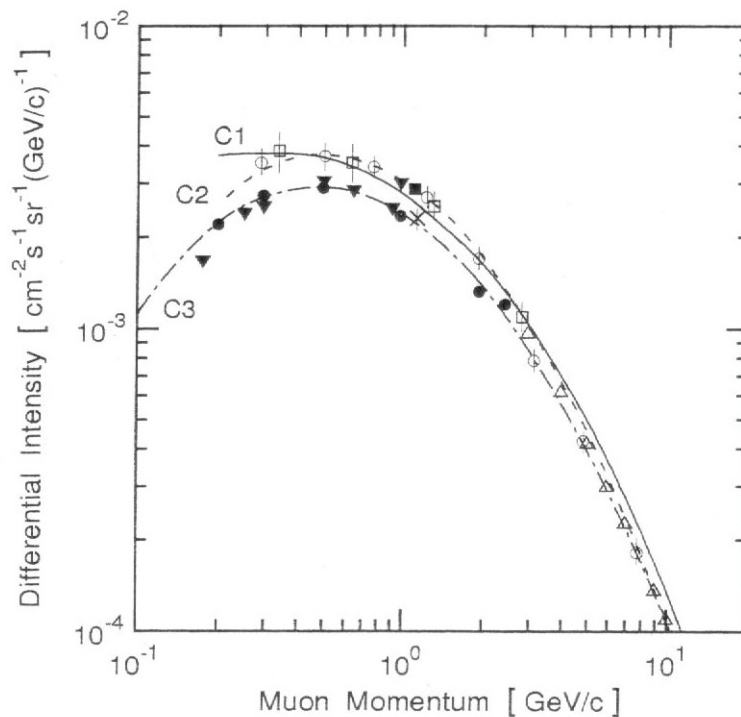
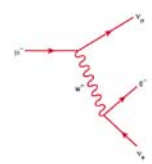

Figure 4. Muon momentum spectrum at sea level. The curves are fits to various data sets (shown as geometric shapes). Figure is taken from reference [Greider, p399].



We therefore need a way to correct for variations in the shape of the muon energy spectrum in the region from about 160 MeV – 800 MeV. (Corresponding to momentums's $p = 120 \text{ MeV}/c - 790 \text{ MeV}/c$.) We do this by first measuring the muon stopping rate at two different elevations ($\Delta h = 3000$ meters between Taos, NM and Dallas, TX) and then computing the ratio R_{raw} of raw stopping rates. ($R_{\text{raw}} = \text{Dallas}/\text{Taos} = 0.41 \pm 0.05$) Next, using the above expression for the transit time between the two elevations, we compute the transit time in the muon's rest frame ($t' = 1.36\tau$) for vertically travelling muons and calculate the corresponding theoretical stopping rate ratio $R = \exp(-t'/\tau) = 0.257$. We then compute the double ratio $R_0 = R_{\text{raw}}/R = 1.6 \pm 0.2$ of the measured stopping rate ratio to this theoretical rate ratio and interpret this as a correction factor to account for the increase in muon flux between about $E = 160 \text{ MeV}$ and $E = 600 \text{ MeV}$. This correction is to be used in all subsequent measurements for any pair of elevations.

To verify that the correction scheme works, we take a new stopping rate measurement at a different elevation ($h = 2133$ meters a.s.l. at Los Alamos, NM), and compare a new stopping rate ratio measurement with our new, corrected theoretical prediction for the stopping rate ratio $R_\mu = R_0 R = 1.6 \exp(-t'/\tau)$. We find $t' = 1.06\tau$ and $R_\mu = 0.55 \pm 0.06$. The raw measurements yield $R_{\text{raw}} = 0.55 \pm 0.02$, showing very good agreement. (That the central values match exactly is a happy coincidence.)

For your own time dilation experiment, you could first measure the raw muon stopping rate at an upper and lower elevation. Accounting for energy loss between the two elevations, you first calculate the transit time t' in the muon's rest frame and then a naïve theoretical lower elevation stopping rate. This naïve rate should then be multiplied by the muon spectrum correction factor 1.6 ± 0.2 before comparing it to the measured rate at the lower elevation. Alternatively, you could measure the lower elevation stopping rate, divide by the correction factor, and then account for energy loss before predicting what the upper elevation stopping rate should be. You would then compare your prediction against a measurement.

Electronics

A block diagram of the readout electronics is shown in figure 5. The logic of the signal processing is simple. Scintillation light is detected by a photomultiplier tube (PMT) whose output signal feeds a two-stage amplifier. The amplifier output then feeds a voltage comparator (“discriminator”) with adjustable threshold. This discriminator produces a TTL output pulse for input signals above threshold and this TTL output pulse triggers the timing circuit of the FPGA. A second TTL output pulse arriving at the FPGA input within a fixed time interval will then stop and reset the timing circuit. (The reset takes about 1 msec during which the detector is disabled.) The time interval between the start and stop timing pulses is the data sent to the PC via the communications module that is used to determine the muon lifetime. If a second TTL pulse does not arrive within the fixed time interval, the timing circuit is reset automatically for the next measurement.

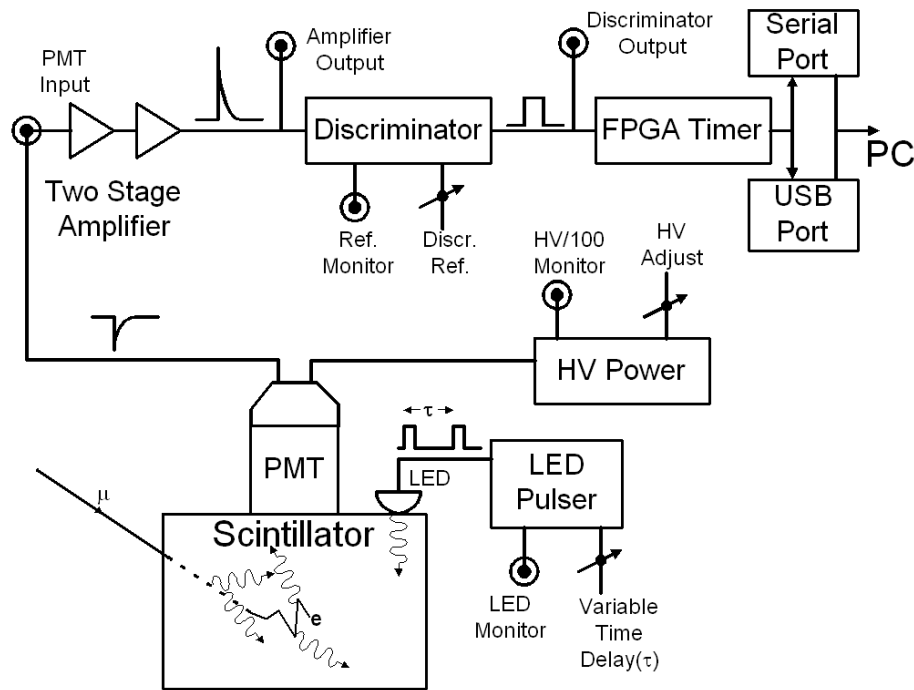
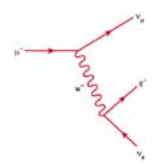

Figure 5. Block diagram of the readout electronics. The amplifier and discriminator outputs are available on the front panel of the electronics box. The HV supply is inside the detector tube.

The front panel of the electronics box is shown in figure 6. The amplifier output is accessible via the BNC connector labeled *Amplifier output*. Similarly, the comparator output is accessible via the connector labeled *Discriminator output*. The voltage level against which the amplifier output is compared to determine whether the comparator



triggers can be adjusted using the “Threshold control” knob. The threshold voltage is monitored by using the red and black connectors that accept standard multimeter probe leads. The toggle switch controls a beeper that sounds when an amplifier signal is above the discriminator threshold. The beeper can be turned off.

The back panel of the electronics box is shown in figure 7. An extra fuse is stored inside the power switch.

Figure 8 shows the top of the detector cylinder. DC power to the electronics inside the detector tube is supplied from the electronics box through the connector *DC Power*. The high voltage (HV) to the PMT can be adjusted by turning the potentiometer located at the top of the detector tube. The HV level can be measured by using the pair of red and black connectors that accept standard multimeter probes. The HV monitor output is 1/100 times the HV applied to the PMT.

A pulser inside the detector tube can drive a light emitting diode (LED) imbedded in the scintillator. It is turned on by the toggle switch at the tube top. The pulser produces pulse pairs at a fixed repetition rate of 100 Hz while the time between the two pulses comprising a pair is adjusted by the knob labeled *Time Adj.* The pulser output voltage is accessible at the connector labeled *Pulse Output*.

For reference, figure 9 shows the output directly from the PMT into a 50Ω load. Figure 10 shows the corresponding amplifier and discriminator output pulses.



Figure 6. Front of the electronics box.

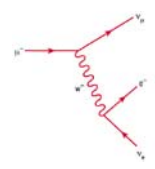

Figure 7. Rear of electronics box. The communications ports are on the left. Use only one.

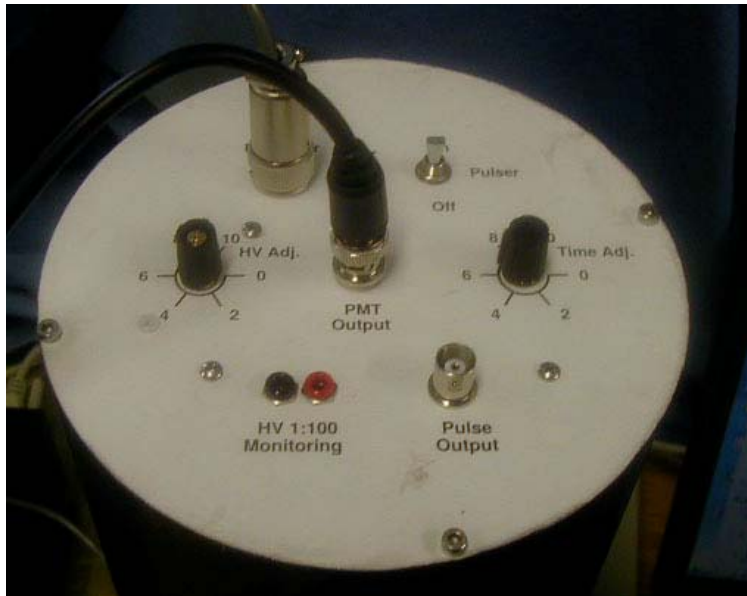

Figure 8. Top view of the detector lid. The HV adjustment potentiometer and monitoring ports for the PMT are located here.

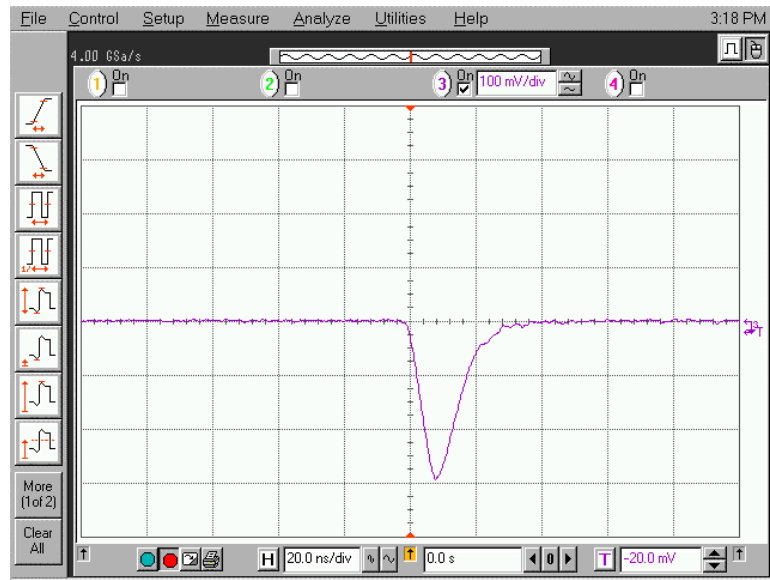
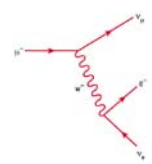

Figure 9. Output pulse directly from PMT into a 50Ω load. Horizontal scale is 20 ns/div and vertical scale is 100 mV/div.

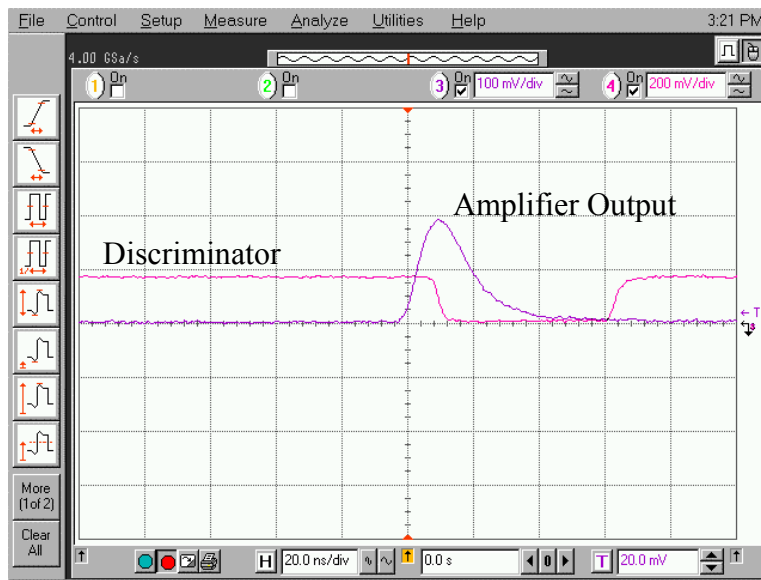
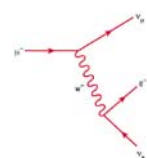

Figure 10. Amplifier output pulse from the input signal from figure 9 and the resulting discriminator output pulse. Horizontal scale is 20 ns/div and the vertical scale is 100 mV/div (amplifier output) and 200 mV/div (discriminator output).



Software and User Interface

Software is used to both help control the instrument and to record and process the raw data. There is also software to simulate muon decay data. All software is contained on the CD that accompanies the instrument and can also be freely downloaded from www.muon.edu. (Both Microsoft and Linux operating systems are supported.) Source code for the user interface and the data fitting software is written in the Tcl/Tk scripting language and is provided. You should find the folders/directories shown in figure 11 on the supplied CD.

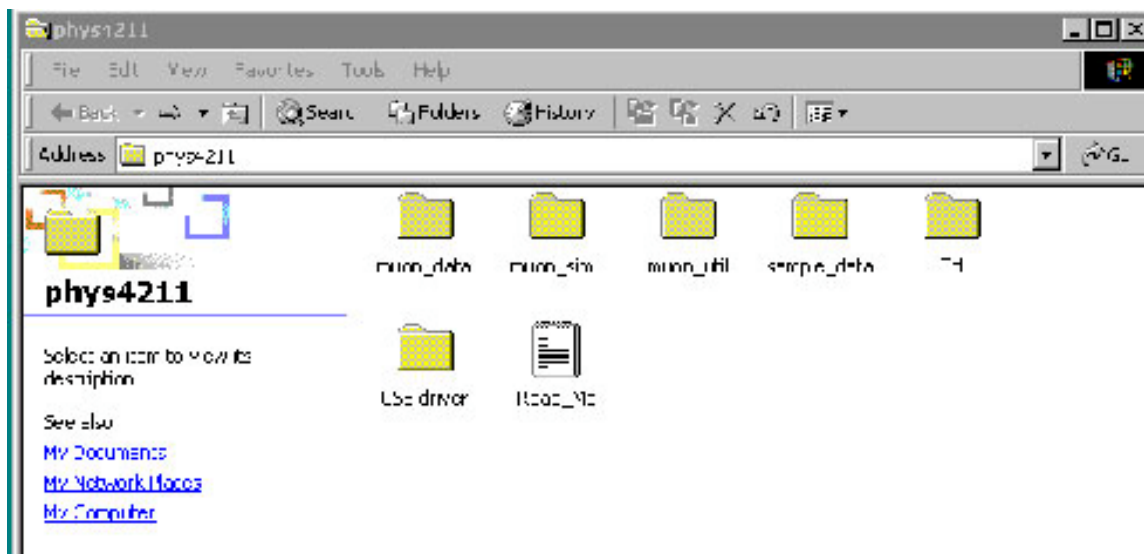
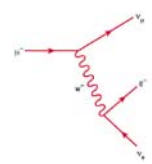

Figure 11. Muon Physics Folders

All of the software can be run from either the CD or copied to disk. The muon decay simulation software can be run without any of the detector electronics present. You should copy all six folders on the CD to a convenient directory. Table 2 lists the folders and describes the software they contain.

Table 2. Important Folders

Folder name	Folder Description
muon_data	Main executable and data files
muon_simu	Simulation program and simulated data
muon_util	Utility programs
sample_data	Sample data file(s)
Tcl	User interface source code
USB Driver	USB driver software



The program you will probably use the most is *muon*, located in the folder *muon_data*. This is the principal data acquisition program used to collect real data. This program stores its data in one of two files: the file named *data* or a file named with the date on which the data was collected derived from the year, month, day and time, in that order, when the date is written in numerical form. (For example, the file 03-07-15:39 corresponds to a data file written 15 July 2003 at 3:39pm. Minutes and hours are written in 24-hour notation.) Real data files are automatically written to the folder *muon_data*.

Files with the extension “tcl” and “dll” are support programs that you do not need to modify for normal running. The Tcl files are however useful to read if you want to see how the user interface and our curve fitter are written in the Tcl/Tk scripting language.

The program *muon* is the main data acquisition program. After you launch it, you will first see the user interface shown in figure 12. The interface allows you to set port settings on your PC, to observe various data rates, to control how data is displayed on the PC, and to fit the collected data.

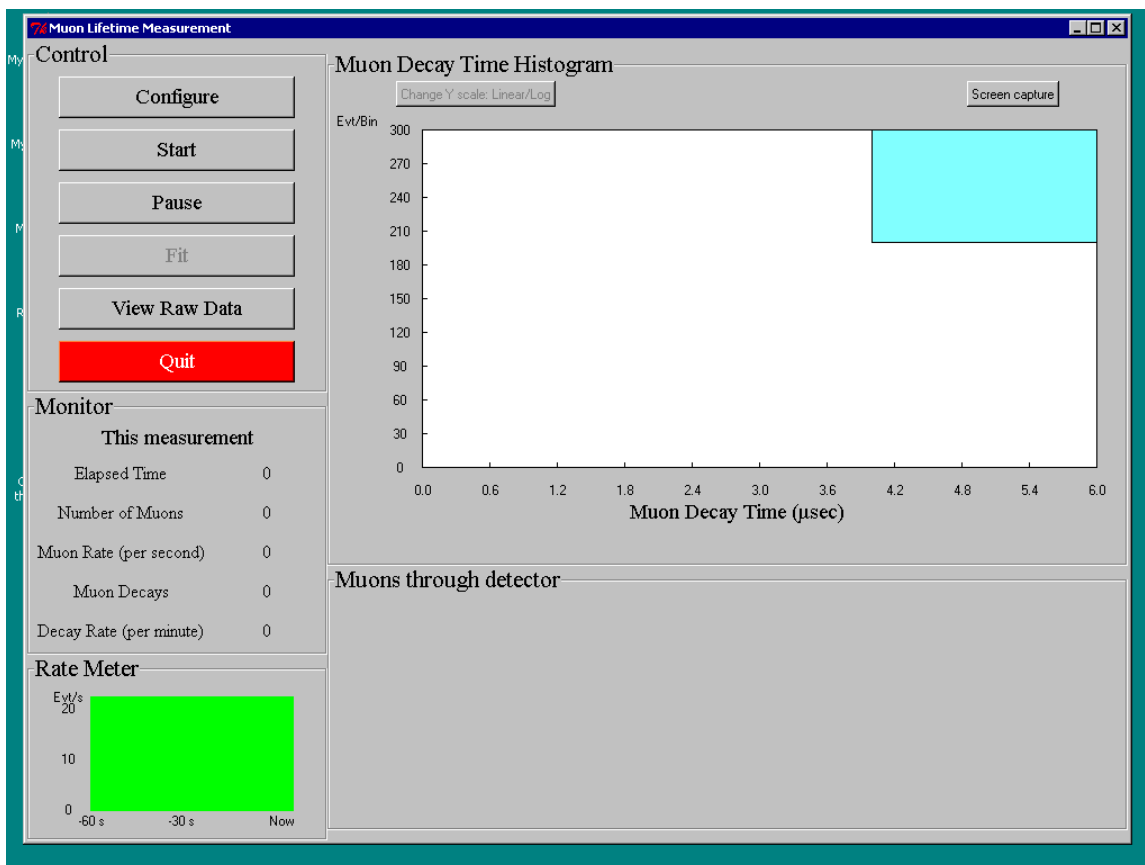
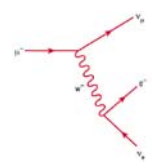

Figure 12. User Interface

There are 5 sections to the main display panel:

- Control
- Muon Decay Time Histogram
- Monitor
- Rate Meter
- Muons through detector

Control

The *Configure* sub-menu is shown in figure 13. This menu allows you to specify which communications port (*com1*, *com2*, *com3* or *com4*) that you will connect to the electronics box. Select either *com1* or *com2* if you will use a serial port for communication. Typically, you will have only a single serial port on your PC so in this case you would select *com1*. (The serial port on your PC is the D-shaped connector with 9 pins.) If you select the wrong port, an error message will eventually appear after you try

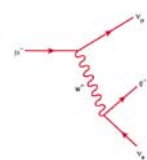

to start the data acquisition (see below), telling you that the port you selected cannot be opened.

If you wish to use the USB port, then connect to the USB port on your computer, select com2 and follow the instructions below for starting the program. If your PC cannot find the USB port, then com2 is not the correct port selection or you lack the USB driver in the first place. To correct the first situation, examine the folder “/system/hardware devices/communications” and find out what port other than com1 exists. Choose this port.

If you need to install the USB driver, then the Windows operating system will inform you of such and ask you where it can find it. In this case just enter data into the pop-up window pointing to the location of the driver, contained in the *USB driver* folder on the included CD. The Windows operating system will then automatically assign a port name that you can determine by examining the folder “/system/hardware devices/communications”.

The maximum x-axis value for the histogram of the muon decay times and the number of data bins is also set here. There are also controls for reading back all ready collected data.

The blue colored *Save/Exit* switch is used to finalize all your communication and histogramming selections.

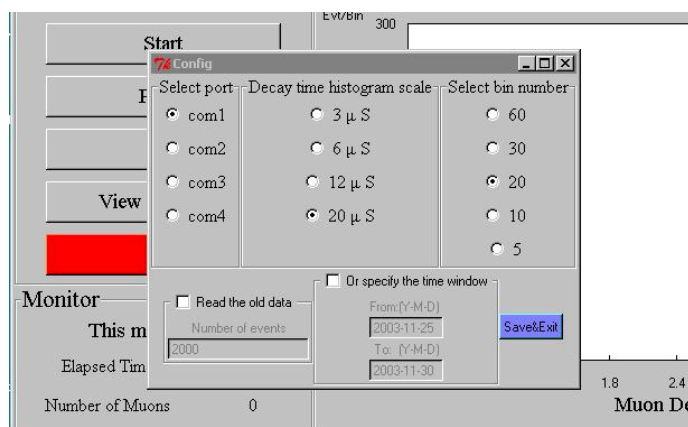
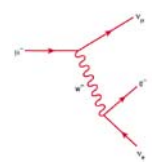

Figure 13. Configure Sub-Menu

The *Start* button in the user interface initiates a measurement using the settings selected from the configure menu. After selecting it, you will see the “Rate Meter” and the “Muons through detector” graphs show activity.

The *Pause* button temporarily suspends data acquisition so that the three graphs stop being updated. Upon selection, the button changes its name to *Resume*. Data taking resumes when the button is selected a second time.



The *Fit* button when selected will prompt the user for a password. (The instructor can change the password.) If the correct password is entered, the data displayed in the decay time histogram is fit and the results displayed in the upper right hand corner of the graph. Data continues to be collected and displayed. The fit curve drawn through the data points disappears once a new data point is collected but results of the fit remain.

The *View Raw Data* button opens a window that allows you to display the timing data for a user selected number of events, with the most recent events read in first. Here an event is any signal above the discriminator threshold so it includes data from both through going muons as well as signals from muons that stop and decay inside the detector. Each raw data record contains two fields of information. The first is a time, indicating the year, month, day, hour, minute and second, reading left to right, in which the data was recorded. The second field is an integer that encodes two kinds of information. If the integer is less than 40000, it is the time between two successive flashes, in units of nanoseconds. If the integer is greater than or equal to than 40000, then the units position indicates the number of “time outs,” (instances where a second scintillator flash did not occur within the preset timing window opened by the first flash). See the data file format below for more information. Typically, viewing raw data is a diagnostic operation and is not needed for normal data taking.

The *Quit* button stops the measurement and asks you whether you want to save the data. Answering *No* writes the data to a file that is named after the date and time the measurement was originally started, i.e., 03-07-13-17-26.data. Answering *Yes* appends the data to the file *muon.data*. The file *muon.data* is intended as the main data file.

Data file format

Timing information about each signal above threshold is written to disk and is contained either in the file *muon.dat* or a file named with the date of the measurement session. Which file depends on how the data is saved at the end of a measurement session

The first field is an encoded positive integer that is either the number of nanoseconds between successive signals that triggered the readout electronics, or the number of “timeouts” in the one-second interval identified by the corresponding data in the second column. An integer **less** than 40000 is the time, measured in nanoseconds, between successive signals and, background aside, identifies a muon decay. Only data of this type is entered automatically into the decay time histogram.

An integer **greater than or equal to** 40000 corresponds to the situation where the time between successive signals exceeded the timing circuit’s maximum number of 40000 clock cycles. A non-zero number in the units place indicates the number of times this “timeout” situation occurred in the particular second identified by the data in the first field. For example, the integer 40005 in the second field indicates that the readout circuit was triggered 5 times in a particular second but that each time the timing circuit reached its maximum number of clock cycles before the next signal arrived.

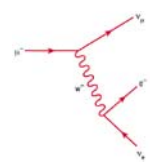

The second field is the number of seconds, as recorded by the PC, from 1 January 1970, a date conventional in computer programming.

Monitor

This panel shows rate-related information for the current measurement. The elapsed time of the current measurement is shown along with the accumulated number of times from the start of the measurement that the readout electronics was triggered (*Number of Muons*). The *Muon Rate* is the number of times the readout electronics was triggered in the previous second. The number of pairs of successive signals, where the time interval between successive signals is less than the maximum number of clock cycles of the timing circuit, is labeled *Muon Decays*, even though some of these events may be background events and not real muon decays. Finally, the number of muon decays per minute is displayed as *Decay Rate*.

Rate Meter

This continuously updated graph plots the number of signals above discriminator threshold versus time. It is useful for monitoring the overall trigger rate.

Muons through Detector

This graph shows the time history of the number of signals above threshold. Its time scale is automatically adjusted and is intended to show time scales much longer than the rate meter. This graph is useful for long term monitoring of the trigger rate. Strictly speaking, it includes signals from not only through going muons but any source that might produce a trigger. The horizontal axis is time, indicated down to the second. The scale is sliding so that the far left-hand side always corresponds to the start of the measurement session. The bin width is indicated in the upper left-hand portion of the plot.

Muon Decay Time Histogram

This plot is probably the most interesting one to look at. It is a histogram of the time difference between successive triggers and is the plot used to measure the muon lifetime. The horizontal scale is the time difference between successive triggers in units of microseconds. Its maximum displayed value is set by the *Configure* menu. (All time differences less than 20 μsec are entered into the histogram but may not actually be displayed due to menu choices.) You can also set the number of horizontal bins using the same menu. The vertical scale is the number of times this time difference occurred and is adjusted automatically as data is accumulated. A button (*Change y scale Linear/Log*) allows you to plot the data in either a linear-linear or log-linear fashion. The horizontal error bars for the data points span the width of each timing bin and the vertical error bars are the square root of the number of entries for each bin.

The upper right hand portion of the plot shows the number of data points in the histogram. Again, due to menu selections not all points may be displayed. If you have

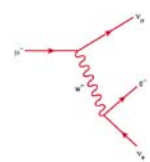

selected the *Fit* button then information about the fit to the data is displayed. The muon lifetime is returned, assuming muon decay times are exponentially distributed, along with the chi-squared per degree of freedom ratio, a standard measure of the quality of the fit. (See Bevington in the reference section for more details.)

A *Screen capture* button allows you to produce a plot of the display. Select the button and then open the *Paint* utility (in Windows) and execute the *Paste* command under the *Edit* pull-down menu.

The Lifetime Fitter

The included muon lifetime fitter for the decay time histogram assumes that the distribution of times is the sum of an exponential distribution and a flat distribution. The exponential distribution is attributed to real muon decays while the flat distribution is attributed to background events. The philosophy of the fitter is to first estimate the flat background from the data at large nominal decays times and to then subtract this estimated background from the original distribution to produce a new distribution that can then be fit to a pure exponential.

The background estimation is a multi-step process. Starting with the raw distribution of decay times, we fit the distribution with an exponential to produce a tentative lifetime τ' . We then fit that part of the raw distribution that have times greater than $5\tau'$ with a straight line of slope zero. The resulting number is our first estimate of the background. We next subtract this constant number from all bins of the original histogram to produce a new distribution of decay times. Again, we fit to produce a tentative lifetime τ'' and fit again that part of this new distribution that have times greater than $5\tau''$. The tentative background level is subtracted from the previous distribution to produce a new distribution and the whole process is repeated again for a total of 3 background subtraction steps.

If you end up using your own fitter, you should exclude from your fit those counts in your decay time histogram with decay times of 80 ns or less. The readout electronics are not fully efficient for counting such short decay times. (We ignore such events in our own fitter.)

Muon Decay Simulation

Simulated muon decay data can be generated using the program *muonsimu* found in the *muon_simu* folder. Its interface and its general functionality are very similar to the program *muon* in the *muon_data* folder. The simulation program *muonsimu* lets you select the decay time of the muon and the number of decays to simulate. Simulated data is stored in exactly the same format as real data.

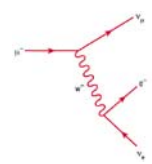

Utility Software

The folder *muon_util* contains several useful programs that ease the analysis of decay data. The executable file *sift* sifts through a raw decay data file and writes to a file of your choosing only those records that describe possible muon decays. It ignores records that describe timing data inconsistent with actual muon decay.

The executable file *merge* merges two data files of your choosing into a single file of your choosing. The data records are time ordered according to the date of original recording so that the older the record the earlier it occurs in the merged file.

The executable file *ratecalc* calculates the average trigger rate (per second) and the muon decay rate (per minute) from a data file of your choosing. The returned errors are statistical.

The executable *freewrap* is the compiler for any Tcl/Tk code that you write or modify. If you modify a Tcl/Tk script, you need to compile it before running it. On a Windows machine you do this by opening a DOS window, and going to the *muon_util* directory. You then execute the command *freewrap your_script.tcl*, where *your_script.tcl* is the name of your Tcl/Tk script. Do not forget the *tcl* extension!

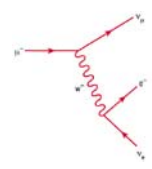

References

Instrumentation and Technique

- Leo, W. R., *Techniques for Nuclear and Particle Physics Experiments*, (1994, Springer-Verlag, New York).
- Owens, A., and MacGregor, A. E., *Am. J. Phys.* **46**, 859 (1978).
- Ward, T. et al., *Am. J. Phys.* **53**, 542 (1985).
- Ziegler, J. F., *Nuclear Instrumentation and Methods*, **191**, (1981) pp. 419-424.
- Zorn, C., in *Instrumentation in High Energy Physics*, ed. F. Sauli, (1992, World Scientific, Singapore) pp. 218-279.

Cosmic Rays

- Friedlander, M.W., *A Thin Cosmic Rain, Particles from Outer Space*, (2000, Harvard University Press, Cambridge, USA).
- Gaisser, T.K., *Cosmic Rays and Particle Physics*, (1990, Cambridge University Press, Cambridge).
- Greider, P.K.F., *Cosmic Rays at Earth*, (2001, Elsevier, Amsterdam).
- Kremer, J. et al., *Phys. Rev. Lett.* **83**, 4241 (1999).
- Longair, M.S., *High Energy Astrophysics, vol 1.*, (1992, Cambridge University Press, Cambridge).
- Motoki, M. et al., Proc. of International Cosmic Ray Conference (ICRC) 2001, 927 (2001).
- Neddermeyer, S.H. and Anderson, C.D., *Phys. Rev.* **51**, 884 (1937).
- Rasetti, F., *Phys. Rev.* **59**, 706 (1941); **60**, 198 (1946).
- Simpson, J.A., Elemental and Isotopic Composition of the Galactic Cosmic Rays, in *Rev. Nucl. Part. Sci.*, **33**, p. 330.
- Thorndike, A.M., *Mesons, a Summary of Experimental Facts*, (1952, McGraw-Hill, New York).

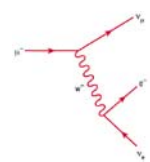

General

- <http://www.pdg.lbl.gov>
- http://people.hofstra.edu/faculty/Stefan_Waner/RealWorld/integral/integral.html
- <http://aero.stanford.edu/StdAtm.html>
- Bevington, P.R. and D.K. Robinson, *Data Reduction and Error Analysis for the Physical Sciences*, 2ed., (1992, McGraw-Hill, New York).
- Evans, R.D., *The Atomic Nucleus*, (1955, McGraw-Hill, New York) chapter 18
- Perkins, D.H., *Introduction to High Energy Physics*, 4ed., (2000, Cambridge University Press, Cambridge).
- Rossi, B., *High-Energy Particles*, (1952, Prentice-Hall, Inc., New York).
- Taylor, J.R., *An Introduction to Error Analysis*, 2ed., (1997, University Science Books, Sausalito, CA).
- Weissenberg, A.O., *Muons*, (1967, North Holland Publishing, Amsterdam).

Muon Lifetime in Matter

- Bell, W.E. and Hincks, E.P., *Phys. Rev.* **88**, 1424 (1952).
- Eckhause, M. et al., *Phys. Rev.* **132**, 422 (1963).
- Fermi, E. et al., *Phys. Rev.* **71**, 314 (1947).
- Primakoff, H., *Rev. Mod. Phys.* **31**, 802 (1959).
- Reiter, R.A. et al., *Phys. Rev. Lett.* **5**, 22 (1960).
- Wheeler, J.A., *Rev. Mod. Phys.* **21**, 133 (1949)



Getting Started

You cannot break anything unless you drop the detector on the floor or do something equally dramatic. Every cable you need is provided, along with a 50Ω terminator.

The black aluminum cylinder (“detector”) can be placed in the wooden pedestal for convenience. (The detector will work in any orientation.) Cable types are unique. Connect the power cable and signal cable between the electronics box and the detector. Connect the communication cable between the back of the electronics box and your PC (or laptop). Use **either** the USB connection or the serial port, **but not both**.

Turn on power to the electronics box. (Switch is at rear.) The red LED power light should now be steadily shining. The green LED may or may not be flashing.

Set the HV between -1100 and -1200 Volts using the knob at the top of the detector tube. The exact setting is not critical and the voltage can be monitored by using the multimeter probe connectors at the top of the detector tube.

If you are curious, you can look directly at the output of the PMT using the *PMT Output* on the detector tube and an oscilloscope. (A digital scope works best.) **Be certain to terminate the scope input at 50Ω or your signal will be distorted.** You should see a signal that looks like figure 8. The figure shows details like scope settings and trigger levels.

Connect the BNC cable between *PMT Output* on the detector and *PMT Input* on the box. Adjust the discriminator setting on the electronics box so that it is in the range $180 - 220$ mV. The green LED on the box front panel should now be flashing.

You can look at the amplifier output by using the *Amplifier Output* on the box front panel and an oscilloscope. **The scope input impedance must be 50Ω .** Similarly, you can examine the output of the discriminator using the *Discriminator Output* connector. Again, the scope needs to be terminated at 50Ω . Figure 10 shows typical signals for both the amplifier and discriminator outputs on the same plot. Details about scope time settings and trigger thresholds are on the plot.

Insert the software CD into your PC and copy all the folders/directories into a convenient folder/directory on your PC.

Open the folder/directory *muon_data* and launch the program *muon.exe*. (Windows may hide the *.exe* extension.) You should now see user interface as shown in figure 12.

Configure the port on your PC. See the material above under *Control* in the *Software and User Interface* section for details. Choose your histogramming options. Click on the *Save/Exit* button.

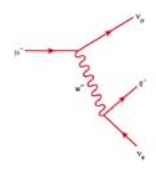

Click on *Start*. You should see the rate meter at the lower left-hand side of your computer screen immediately start to display the raw trigger rate for events that trigger the readout electronics. The mean rate should be about 6 Hz or so.



Suggested Student Exercises

1) Measure the gain of the 2-stage amplifier using a sine wave.

Apply a 100kHz 100mV peak-to-peak sine wave to the input of the electronics box input. Measure the amplifier output and take the ratio V_{out}/V_{in} .

Q: Increase the frequency. How good is the frequency response of the amp?

Q: Estimate the maximum decay rate you could observe with the instrument.

2) Measure the saturation output voltage of the amp.

Increase the magnitude of the input sine wave and monitor the amplifier output.

Q: Does a saturated amp output change the timing of the FPGA? What are the implications for the size of the light signals from the scintillator?

3) Examine the behavior of the discriminator by feeding a sine wave to the box input and adjusting the discriminator threshold. Monitor the discriminator output and describe its shape.

4) Measure the timing properties of the FPGA:

a) Using the pulser on the detector, measure the time between successive rising edges on an oscilloscope. Compare this number with the number from software display.

b) Measure the linearity of the FPGA:

Alter the time between rising edges and plot scope results v. FPGA results;

Can use time between 1 μ s and 20 μ s in steps of 2 μ s.

c) Determine the timeout interval of the FPGA by gradually increasing the time between successive rising edges of a double-pulse and determine when the FPGA no longer records results;

Q: What does this imply about the maximum time between signal pulses?

d) Decrease the time interval between successive pulses and try to determine/bound the FPGA internal timing bin width.

Q: What does this imply about the binning of the data?

Q: What does this imply about the minimum decay time you can observe?

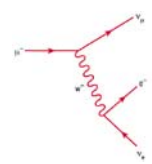

- 5) Adjust (or misadjust) discriminator threshold.
Increase the discriminator output rate as measured by the scope or some other means.
Observe the raw muon count rate and the spectrum of "decay" times. (This exercise needs a digital scope and some patience since the counting rate is "slowish.")

- 6) What HV should you run at? Adjust/misadjust HV and observe amp output. (We know that good signals need to be at about 200 mV or so before discriminator, so set discriminator before hand.) With fixed threshold, alter the HV and watch raw muon count rate and decay spectrum.

- 7) Connect the output of the detector can to the input of the electronics box. Look at the amplifier output using a scope. (A digital scope works best.) **Be sure that the scope input is terminated at 50Ω.** What do you see? Now examine the discriminator output simultaneously. Again, be certain to terminate the scope input at 50Ω. What do you see?

- 8) Set up the instrument for a muon lifetime measurement.
Start and observe the decay time spectrum.
Q: The muons whose decays we observe are born outside the detector and therefore spend some (unknown) portion of their lifetime outside the detector. So, we never measure the actual lifetime of any muon. Yet, we claim we are measuring the lifetime of muons. How can this be?

- 9) Fitting the decay time histogram can be done with the included fitter or with your own.

- 10) From your measurement of the muon lifetime and a value of the muon mass from some trusted source, calculate the value of Fermi coupling constant G_F . Compare your value with that from a trusted source.

- 11) Using the approach outlined in the text, measure the charge ratio ρ of positive to negative muons at ground level or at some other altitude.

- 12) Following the approach in the manual, measure the muon stopping rate at two different elevations and compare predictions that do and do not assume the time dilation effect of special relativity.

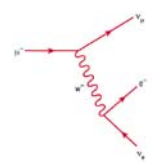

13) Once the muon lifetime is determined, compare the theoretical binomial distribution with an experimental distribution derived from the random lifetime data of individual muon decays. For example, let p be the (success) probability of decay within 1 lifetime, $p = 0.63$. The probability of failure $q = 1 - p$. Take a fresh data sample of 2000 good decay events. For each successive group of 50 events, count how many have a decay time less than 1 lifetime. (On average this is 31.5.) Histogram the number of "successes." This gives you 40 experiments to do. The plot of 40 data points should have a mean at $50 \cdot 0.63$ with a variance $\sigma^2 = Npq = 50 \cdot 0.63 \cdot 0.37 = 11.6$. Are the experimental results consistent with theory?

How to get help

If you get stuck and need additional technical information or if you have physics questions, you can contact either Thomas Coan (coan@mail.physics.smu.edu) or Jingbo Ye (yejb@mail.physics.smu.edu). We will be glad to help you.